

Thank you for purchasing the Louisiana Media Console. Before you begin to assemble your new piece of furniture, please check to ensure that all hardware and parts have been supplied. This page lists all contents included in the carton(s). Follow instructions closely as deviation from them may present a possible safety risk and may void your warranty.

It is recommended that assembly is done on a soft surface such as carpet to avoid any damage.

Care Information

Dust weekly using a soft, clean cloth. Do not use harsh abrasives, chemicals or polishes containing Silicone to as they can damage this finish.

Avoid direct sunlight as this will cause the timber to change colour. It is important to remove moist substances immediately.

Note: Thank you for the purchasing Louisiana Media Console. While great care is taken during production.

This piece may have some subtle natural splitting, cracking or chipping that give a natural vintage look. Such a look is part of the charm and appeal of this crafted timber product and not a manufacturing defect.

Anti Tip Kit (Supplied)

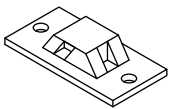

A X 2

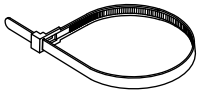

B X 2

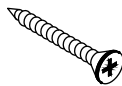

C X 4

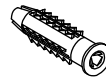

D X 4

Parts:

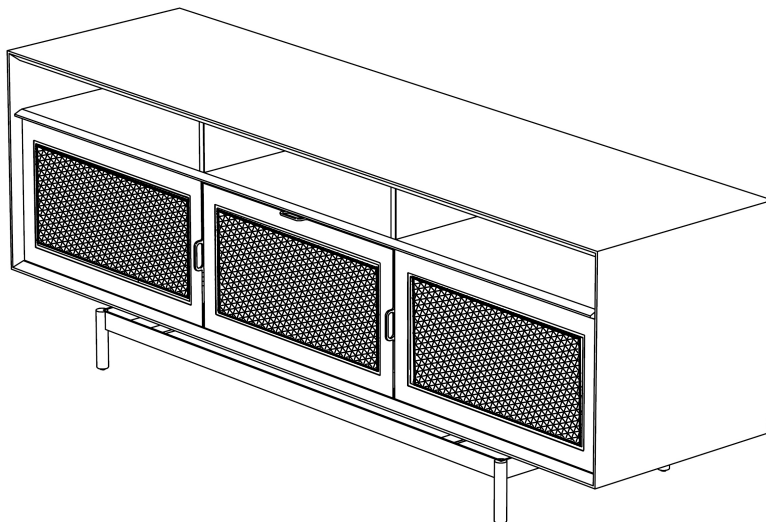

Y X 1

Step 1:

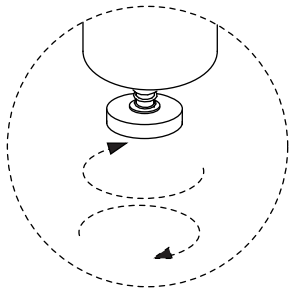
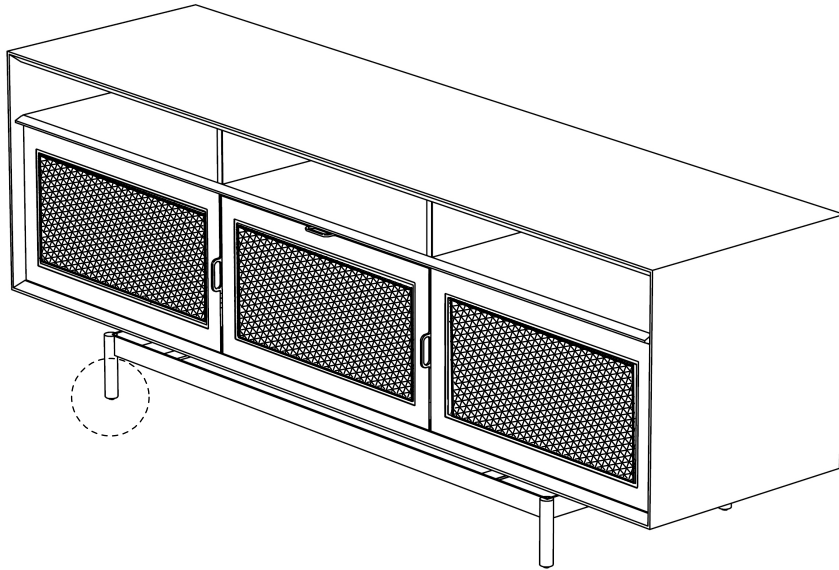

Step 2:

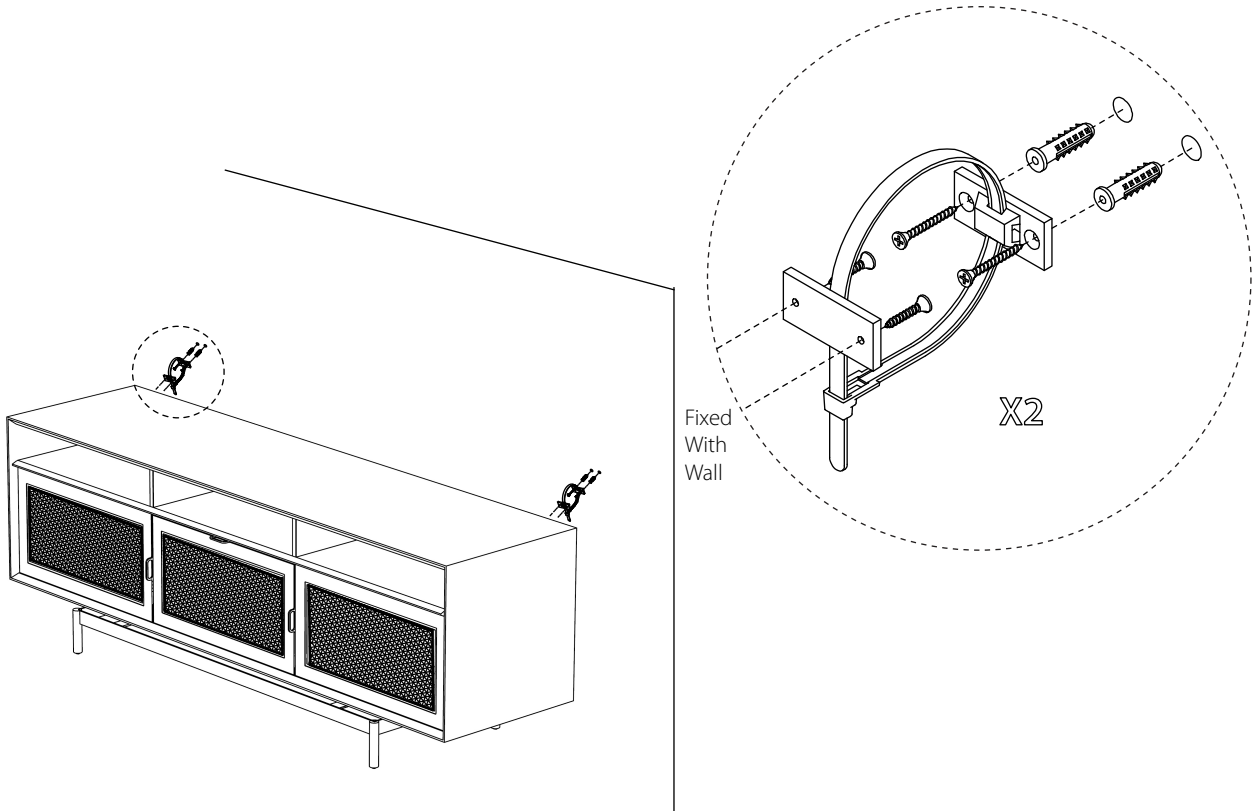

Anti Tip Kit Installation

- 1) Using screws provided and a screwdriver, secure mounting plate(s) to the back of product.
- 2) Noting the location of the product's mounting plate(s), mark and drill holes on the wall for mounting plate(s). Drill pilot holes into marked positions and into a wall stud. NOTE: if wall studs are not available, drill holes slightly smaller than the drywall anchors and insert each anchor until its flange is flush with the wall.
- 3) Using a screwdriver, secure mounting bracket(s) to the wall stud or drywall anchors with screws provided.
- 4) Position product in final location, and secure to the wall by lacing one end of plastic tie(s) through both the wall and product mounting plates, and through the other end, pulling tightly to remove slack. Do not over tighten.