

Thank you for purchasing the Laurel Stool. Before you begin to assemble your new piece of furniture, please check to ensure that all hardware and parts have been supplied. This page lists all contents included in the carton(s). Follow instructions closely as deviation from them may present a possible safety risk and may void your warranty.

It is recommended that assembly is done on a soft surface such as carpet to avoid any damage.

Care Information

Dust weekly using a soft, clean cloth. Do not use harsh abrasives, chemicals or polishes containing Silicone to as they can damage this finish.

Avoid direct sunlight as this will cause the timber to change colour. It is important to remove moist substances immediately.

Note: Thank you for the purchasing Laurel Stool. While great care is taken during production.

This piece may have some subtle natural splitting, cracking or chipping that give a natural vintage look. Such a look is part of the charm and appeal of this crafted timber product and not a manufacturing defect.

Hardware (Supplied)



A X 16
M8x20mm



B X 16
8x16mm



C X 1
5mm

Parts

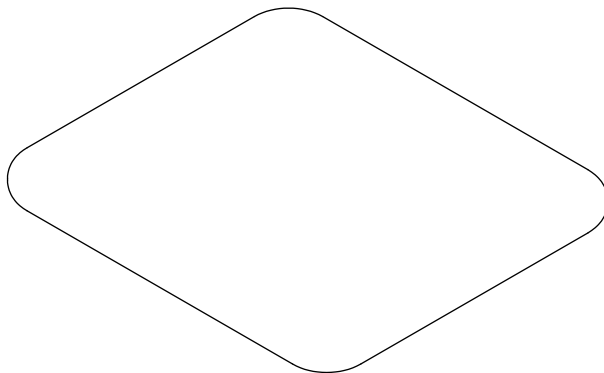

S X 1

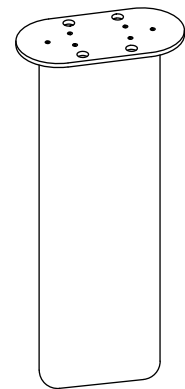

T X 4

Step 1:

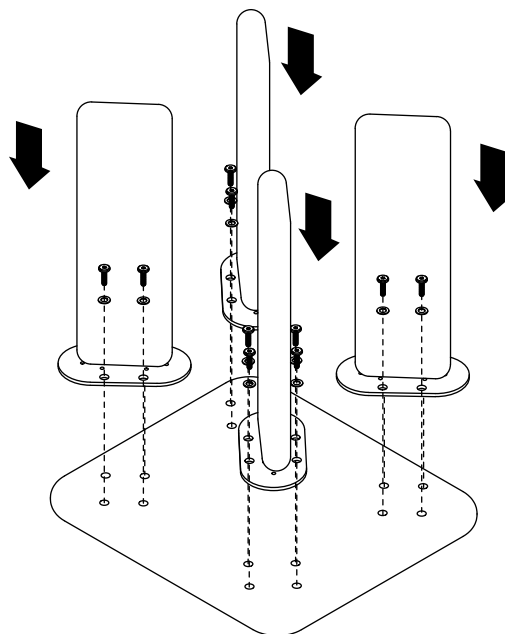
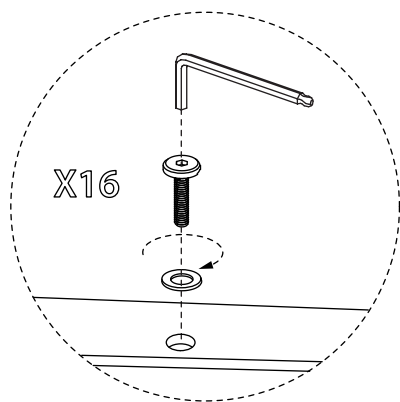

Finish:

